

UNIFORM STATUTORY DECLARATION FORM FOR THE REGISTRATION OF FITTING DESIGNS

NEW BRUNSWICK
NUNAVUT

NOVA SCOTIA
YUKON

PRINCE EDWARD ISLAND
NORTHWEST TERRITORIES

NEWFOUNDLAND AND LABRADOR

| | |
|---|--|
| MANUFACTURERS NAME: <u>Swagelok Company</u> | |
| MANUFACTURERS ADDRESS: <u>29500 Solon Road, Solon, Ohio 44139 USA</u> | |
| PLANT LOCATIONS: <u>Headquarters: 29500 Solon Road, Solon, Ohio 44139 USA (See Attachment A)</u> | |
| CATEGORY OF FITTINGS TO BE REGISTERED. CIRCLE ONE CATEGORY ONLY | |
| <input checked="" type="radio"/> A Pipe fittings, including couplings, tees, elbows, Ys, plugs, unions, pipe caps, or reducers <input type="radio"/> B Flanges: all flanges <input type="radio"/> C Valves: all line valves <input type="radio"/> D Expansion joints, flexible connections, and hose assemblies: all types <input type="radio"/> E Strainers, filters, separators, and steam traps <input type="radio"/> F Measuring devices, including pressure gauges, level gauges, sight glasses, levels, or pressure transmitters <input type="radio"/> G Certified capacity-rated pressure relief devices acceptable as primary over pressure protection on boilers, pressure vessels, piping and fusible plugs <input type="radio"/> H Pressure retaining components that do not fall into one of the above categories <input type="radio"/> N Nuclear components: Class 1 <input type="checkbox"/> Class 2 <input type="checkbox"/> Class 3 <input type="checkbox"/> , (Meeting AECB or ASME requirements) | TITLE OF THE STANDARD OF CONSTRUCTION ASME B31.1 for unlisted components, ASME B31.3 for unlisted components |
| SHOW MANUFACTURERS NAME, TRADEMARK, OR LOGO AS IT WILL APPEAR ON THE PRODUCT Swagelok | TYPE OF CONSTRUCTION FORGED <input type="checkbox"/> WELDED <input type="checkbox"/> WROUGHT <input checked="" type="checkbox"/> CAST <input type="checkbox"/> OTHER <input type="checkbox"/> DESCRIBE OTHER: |
| LIST OF SUPPORTING DOCUMENTATION AND IDENTIFICATION OF THE ACTUAL ITEMS TO BE REGISTERED: <u>ISO 9001:2015 Certificate, Attachment A, Attachment B, Catalog Information and other Support Documents</u> | |

DECLARATION:

I, Joel Feldman, Vice President, Engineering (see note 3) employed by Swagelok Company and being the person having full authority and responsibility for the quality of the end product do solemnly declare that the information contained in this form is true and to the best of my knowledge represents the product for which registration is sought. The dimensions, materials of construction, pressure, temperature ratings, and identification markings are in accordance with the herein named standards. I further declare that the manufacture of these fittings is regulated by a Quality Control Program which extends to each plant where fabrication is done or in part and has been verified by BSI as being suitable for that purpose and I make this declaration conscientiously believing it to be true, and knowing that it is of the same force and effect as if made under oath.

Signature of Declarer: [Signature]
Declared before me at Solon, Ohio
This 10th day of June AD 2019
Commissioner of Oaths
or Notary Public: (sign) [Signature]
(Affix Official seal to the right)

USE THIS SPACE FOR
OFFICIAL SEAL



This space for Regulatory Authority use
This registration must be revalidated after ten (10) years from the date of acceptance.

CRN: 0A21839.5
FID#: 1214

VCR METAL GASKET FACE SEAL FITTINGS

Notes:
1. All fittings shall be registered in the name of the Manufacturer.
2. Each category shall be supported with two Statutory Declaration forms and one copy of supporting documentation.
3. The declaration shall be made by the person having full authority and responsibility for the quality of the end product.
4. Quality control programs shall be resubmitted for validation at a maximum interval of five (5) years.

CRN EXPIRES OCT. 4, 2029 -D.G.

ACCEPTED
PROVINCE OF PRINCE EDWARD ISLAND
COMMUNITIES, LAND & ENVIRONMENT
C.R.N. 0A21839.59
DATE: NOV 15/19
[Signature]
INSPECTION SERVICES SECTION
BOILER/PRESSURE VESSEL BRANCH



Attachment B: Scope of CRN Registration for Swagelok® VCR® and High Flow VCR Metal Gasket Face Seal Fittings (Category A)

This document presents the scope of Swagelok® VCR® and High Flow VCR (HVCR) Metal Gasket Face Seal Fittings covered by this submission for CRN registration. These fittings were designed and evaluated in accordance with ASME B31.1-2016 "Power Piping" for unlisted components and ASME B31.3-2016 "Process Piping" for unlisted components. *OA 21889.5*

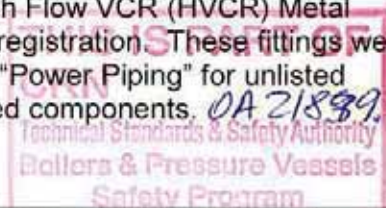

Summary Table

| Product Series (Size) | Pressure Retaining Materials | Pressure Retaining Components | End Connections and Sizes | Maximum Rated Pressure ¹ | | Design Code of Construction |
|-----------------------------|---|-------------------------------|---|-------------------------------------|---|---|
| | | | | At 100°F | At Max Temp (1000°F unless noted otherwise) | |
| -1 VCR ² (1/16") | 316 SS (ASTM A479) | Gland | Tube Socket Weld 1/16" | 9000 psig | 5080 psig | ASME B31.1 (Unlisted Components) and ASME B31.3 (Unlisted Components) |
| -2 VCR (1/8") | 316 SS (ASTM A479) for straight fittings F316 SS (ASTM A182) for shaped fittings | Gland, Body | Tube Socket Weld 1/8" | 7100 psig | 4010 psig | |
| | | | Male Tube Weld 1/16"-1/8" | 11,200-8500 psig | 6320-4800 psig | |
| | | | Tube Butt Weld 1/8" | 8500 psig | 3740 psig | |
| | | | Male NPT 1/16" – 1/8" | 9000 psig | 6210 psig @ 450°F w/sealant | |
| | | | Female NPT 1/16" – 1/8" | 6700-6500 psig | 4620-4480 psig @ 450°F w/sealant | |
| -4 VCR (1/4") | 316 SS (ASTM A479) for straight fittings F316 SS (ASTM A182) for shaped fittings | Gland, Body | Tube Butt Weld 1/4", 6mm | 6800-5100 psig | 2990-2240 psig | |
| | | | Automatic Tube Weld 1/4", 6-8mm | | | |
| | | | Tube Socket Weld 1/4" | 5500 psig | 3100 psig | |
| | | | Reducing Tube Socket Weld 1/8" | 8000 psig | 4520 psig | |
| | | | Male Tube Weld 1/8"-1/4" | 10,000 psig | 5650 psig | |
| | | | Male NPT 1/8"-1/4" | 10,000 psig | 6900 psig @ 450°F w/sealant | |
| | | | Male SAE/MS 9/16-18 | 4500 psig | 4500 psig @ 400°F | |
| | Female NPT 1/8"-1/4" | 8000-6600 psig | 5520-4550 psig @ 450°F w/sealant | | | |
| | 17-4 PH Metal Injection Mold (MPIF Std 35) | Split Nuts | Nuts Only | 5100 psig | 3130 psig @ 650°F | |
| -4 HVCR (1/4") | 316 SS (ASTM A479) for straight fittings F316 SS (ASTM A182) for shaped fittings | Gland, Body | Bodies only | 10,000 psig | 5650 psig | |
| | | | Tube Butt Weld 3/8" Automatic Tube Weld 3/8" | 3300 psig | 1450 psig | |

Notes:

1. Above maximum rated pressures are for fittings with 316L SS Gasket
2. -1 VCR uses -2 VCR size nut and gasket.

Summary Table (cont'd)

| Product Series (Size) | Pressure Retaining Materials | Pressure Retaining Components | End Connections and Sizes | Maximum Rated Pressure ¹ | | Design Code of Construction |
|------------------------------------|--|-------------------------------|---|-------------------------------------|---|---|
| | | | | At 100°F | At Max Temp (1000°F unless noted otherwise) | |
| -6 VCR (3/8") -8 VCR (1/2") | | Gland, Body | Tube Butt Weld 1/4", 3/8", 1/2", 8mm, 10mm, 12mm Automatic Tube Weld 3/8, 1/2", 10mm, 12mm | 3500-3100 psig | 1540-1360 psig | ASME B31.1 (Unlisted Components) and ASME B31.3 (Unlisted Components) |
| | | | Tube Socket Weld 3/8", 1/2" | 4300-3000 psig | 2430-1690 psig | |
| | | | Reducing Tube Socket Weld 1/4" | 3500 psig | 1970 psig | |
| | | | Male Tube Weld 1/4", 3/8", 1/2" | 4300-3500 psig | 2430-1970 psig | |
| | | | Male NPT 1/4", 3/8", 1/2" Female NPT 3/8", 1/2" | 4300 psig | 2960 psig @ 450°F w/sealant | |
| | | | Male SAE/MS 7/8-14, 9/16-18 Tube Fitting 1/8", 1/4", 3/8", 1/2", 3/4", 4mm, 6mm, 8mm, 10mm, 12mm, 18mm | 3500 psig | 3070 psig@400°F 4300 psig | |
| -10 VCR (5/8") | 316 SS (ASTM A479) for straight fittings | Gland, Body | Tube Butt Weld 5/8" | 2800 psig | 1230 psig | |
| | | | Tube Socket Weld 5/8" | 2800 psig | 1410 psig | |
| | | | Male Tube Weld 5/8" | 2800 psig | 1580 psig | |
| -12 VCR (3/4") | F316 SS (ASTM A182) for shaped fittings | Gland, Body | Tube Butt Weld 3/4", 18mm Automatic Tube Weld 3/4", 18mm | 3000-2400 psig | 1320-1050 psig | |
| | | | Tube Socket Weld 3/4" | | | |
| | | | Tube Fitting 1/8", 1/4", 3/8", 1/2", 3/4", 1", 6mm, 12mm, 18mm | 2800 psig | 1580 psig | |
| | | | Male Tube Weld 3/4" | 3700 psig | 2090 psig | |
| | | | Male NPT 3/4" Female NPT 3/4" | 3700 psig | 2550 psig @ 450°F w/sealant | |
| -16 VCR (1") | | Gland, Body | Tube Butt Weld 1" Automatic Tube Weld 1" | 2400 psig | 1050 psig | |
| | | | Tube Socket Weld 1" Male Tube Weld 1" | 3000 psig | 1690 psig | |
| | | | Male NPT 1" Female NPT 1" | 3000 psig | 2070 psig @ 450°F w/sealant | |
| | | | Tube Fitting 1/4", 1/2", 1" | 3000 psig | 1690 psig | |

Note 1. Above maximum rated pressures are for fittings with 316L SS Gasket



Product Description

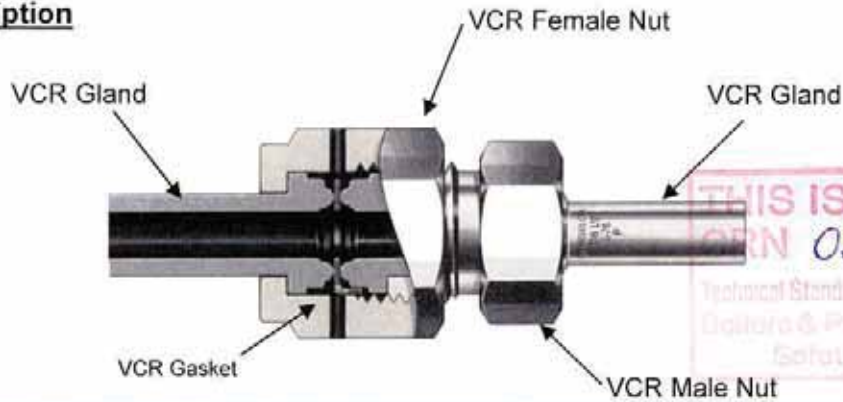

THIS IS PART OF
 CORN 0A21839.5
 Technical Standards & Safety Authority
 Ductile & Pressure Vessels
 Safety Program

Typical VCR Assemblies

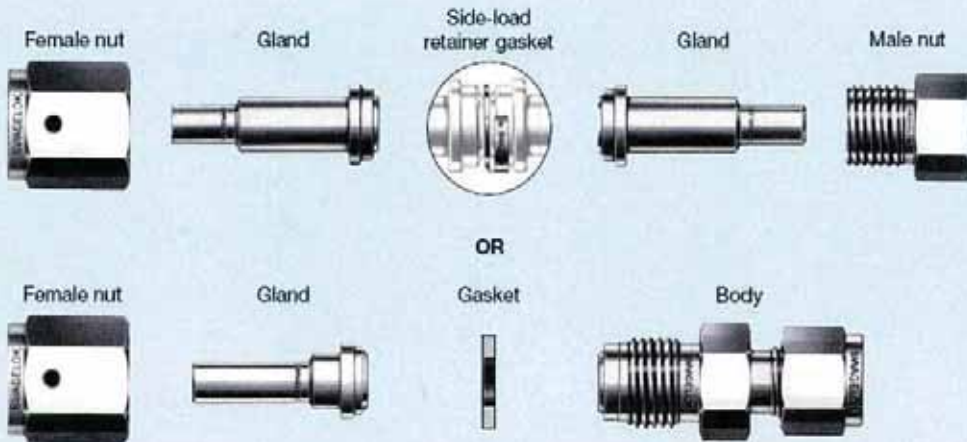







- o High Flow VCR (HVCR) is only offered in the 1/4 in. size. The only difference from the 1/4 in. VCR is a larger inside diameter.

Configurations







| | |
|---|-------------------------|
| VCR/HVCR Glands | |
| VCR/HVCR Male Bodies | |
| VCR/HVCR Shapes (Elbows, Tees, and Crosses) | |
| VCR Female Bodies | |
| VCR Split Nuts | <p>Female Male</p> |

Gland end connections

| Part Description | Sizes |
|---|--|
| Long Tube Butt Weld Short Tube Butt Weld |  1/16 in. - 1 in. |
| Short Automatic Tube Butt Weld Long Automatic Tube Butt Weld |  1/4 in. - 1 in. |
| Socket Weld Short Socket Weld |  1/8 in. - 1 in. |
| Reducing Socket Weld |  1/8 in. and 1/4 in. |
| Male Tube Weld |  1/8 in. - 1 in. |
| Tube Adapter |  1/8 in. to 1 in. |
| High-Flow VCR Gland End |  3/8 in. Tube Butt Weld |

THIS IS PART OF
 CRN *QA 21839.5*
 Technical Standards & Safety Authority
 Boilers & Pressure Vessels
 Safety Program

Body Types

| Part Description | Sizes |
|--|--|
| Tube Fitting |  1/16 in – 1 in |
| Tube Fitting Bulkhead Connector |  1/8 in – 16MM |
| Female NPT |  1/16 in – 1 in. |
| Male NPT |  1/16 in. – 1 in. |
| Male NPT Bulkhead |  1/4 in. |
| Straight Thread O-ring Seal Male Connector |  9/16-18, 7/8-14 |
| Tube Butt Weld Bulkhead Connector |  1/4 in. |

THIS IS PART OF
 CRN 0A 21839.5
 Technical Standards & Safety Authority
 Gullers & Pressure Vessels
 Safety Program

Product Options:

Some of the product options listed below affect the pressure-temperature ratings shown in the Summary Table above, but in all cases the ratings are less than those shown in the above table.

- Gasket Options
 - Nickel
 - Copper
 - Teflon
 - Blind Gaskets
 - Snubber Gaskets

- Pressure Bearing Component Material Options (allowable variations of 316 material) that may affect high temperature rating
 - 316L
 - 316LV (VAR)
 - 316LVV (VIMVAR)

Additional options and non-pressure boundary alterations that do not affect pressure-temperature ratings may be made available within the scope of this approval. Examples of these options are:

- Protective Caps
- Gasket Retainer Assemblies
- Caps and Plugs with Lanyards
- Flow Restrictors
- Fitting and Valve Locking Devices
- Side Load Installation Tool and Tray
- "Bore-through" fitting through holes

Quality System

The Swagelok Company quality system complies with the requirements of ISO 9001:2015. Swagelok Company maintains BSI Certificate of Registration Number FM 01729, which applies to all locations listed on the Certificate.

References

The product catalog does not represent the full scope of the registration but rather details some of the most common options:

- VCR Metal Gasket Face Seal Fittings Product Catalog MS-01-24, Rev. Q



Attachment A. Swagelok Manufacturing Locations

This document lists the Swagelok locations where end item or component level manufacturing activities take place.

| | |
|---|--|
| Swagelok Company 29500 Solon Road Solon, Ohio 44139 USA | Swagelok Company (Falon 1) 348 Bishop Road Highland Heights, Ohio 44143 USA |
| Swagelok Company (Highland) 318 Bishop Road Highland Heights, Ohio 44143 USA | Swagelok Company (Falon 2) 358 Bishop Road Highland Heights, Ohio 44143 USA |
| Swagelok Company (OFC) 29495 F.A. Lennon Drive Solon, Ohio 44139 USA | Swagelok Company (HPF) 6050 Cochran Road Solon, Ohio 44139 USA |
| Swagelok Company (Atlantic) 26651 Curtiss Wright Parkway Willoughby Hills, Ohio 44092 USA | Swagelok Company (Snow Metal) 6060 Cochran Road Solon, Ohio 44139 USA |
| Swagelok Company (Micro) 26653 Curtiss Wright Parkway Willoughby Hills, Ohio 44092 USA | Swagelok Company (Alfred) 29500 Ambina Drive Solon, Ohio 44139 |
| Swagelok Hose Services Company (SHSC) 29900 Solon Industrial Parkway Solon, Ohio 44139 | Swagelok Company (Strongsville) 15400 Foltz Road Strongsville, Ohio 44119 |
| Swagelok (China) Fluid System Technologies Ltd. Changshu Export Process Zone Changshu Economic Development Zone Changshu, Jiangshu 215513 China | Swagelok Limited Ballafletcher Road Tromode IM4 4RA Isle of Man |

